



$$\text{Duty Cycle} = \frac{\text{"on" time}}{\text{"on" time} + \text{"off" time}} \times 100\% \quad 25\% \text{ ED}$$

Coil Data

Maximum "on" time in seconds	20
Watts at 20°C	18.4
Ampere-Turns at 20°C	979

P/N	Resistance ±10% @ 20°C	Coil Turns	Volts DC	Release Current
SH1LC-1240-06	2.0 Ω	320	6	1620 mA
SH1LC-1240-12	7.8 Ω	630	12	820 mA
SH1LC-1240-24	31.3 Ω	1315	24	400 mA

General Parameters

Life Expectancy (Cycles)	200,000
Mass	145 grammes
Plunger Mass	34 grammes
Leadwires 250mm (10")min, UL1007, AWG24	
Insulation Class	A (105°C)
Dielectric Strength 1000V AC, 50/60Hz, 1min	
Insulation Res >100MΩ, 500V DC Megger	

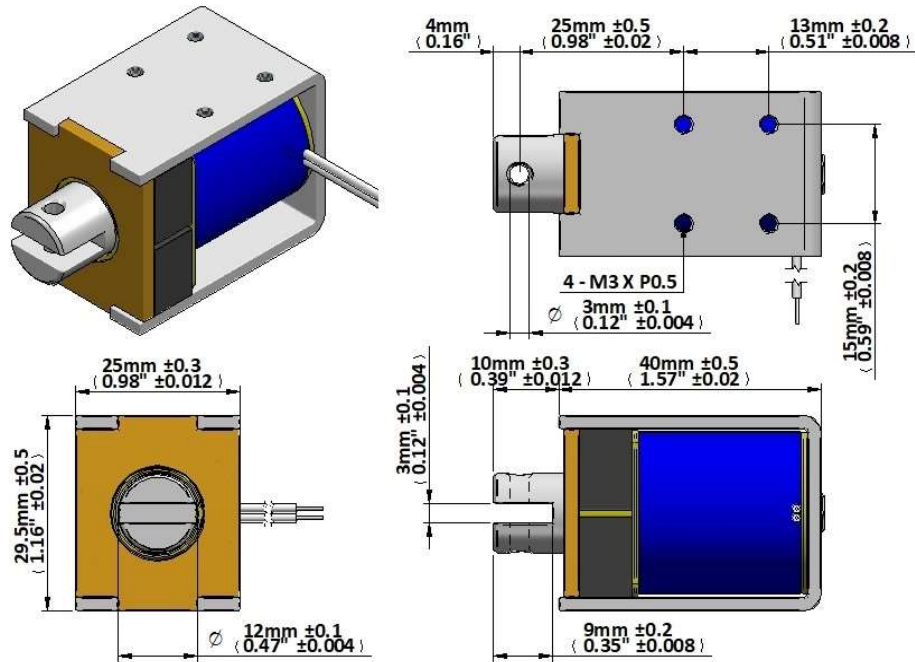

Force (N) vs Displacement (mm)

