

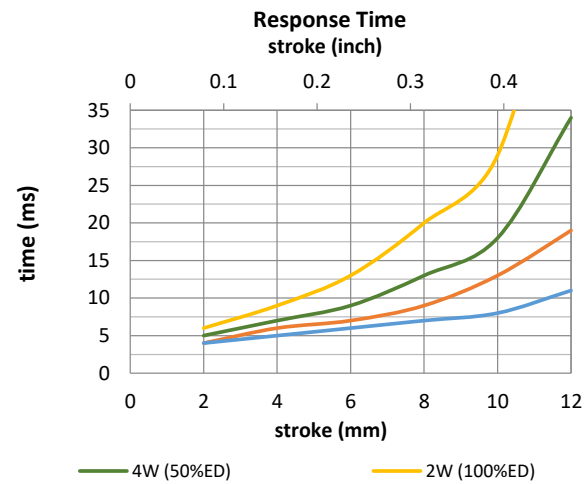

Device drawn in energised condition
 Life Expectancy >250K cycles
 Leadwires UL1007, 26AWG, 300mm

Plunger Mass 5 grammes
 Total Mass 26 grammes

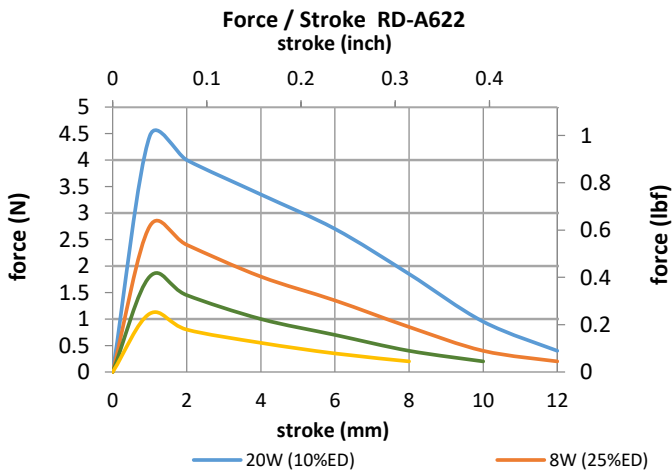
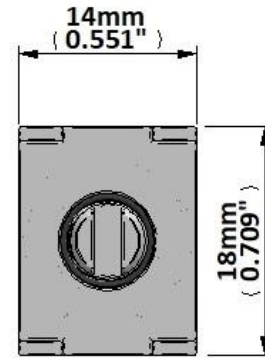
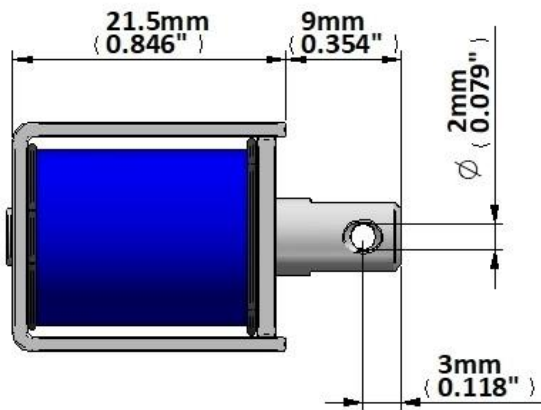
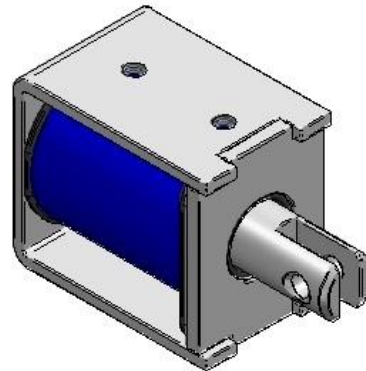
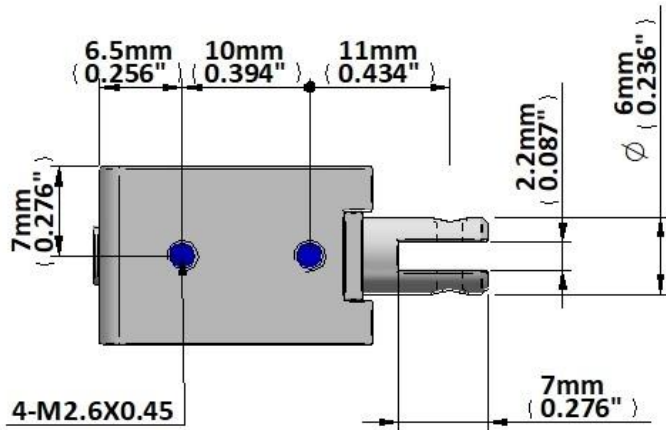

Data at 20°C, device performance measured without heat sink

duty cycle = $\frac{\text{"on" time}}{\text{"on" time} + \text{"off" time}} \times 100\%$		100% cont.	50% or less	25% or less	10% or less	
Max. "on" time in seconds		∞	168	59	16	
watts at 20°C		2.0	4.0	8.0	20.0	
ampere-turns at 20°						
AWG no.	resistance	number of turns	volts DC			
	$\Omega \pm 10\%$ (at 20°C)					
RD-A622-6v	18		6.0	8.5	12.0	19.0
RD-A622-12v	72		12.0	17.0	24.0	38.0
RD-A622-24v	288		24.0	34.0	48.0	76.0

Insulation Resistance >100MΩ, 500VDC Megger

Dielectric Strength 500VAC, 50/60Hz, 1 minute

Class A (105°C) insulation class