



GEEPLUS

Open Frame Solenoid RD-A622

Device drawn in energised condition
 Life Expectancy >250K cycles
 Leadwires UL1007, 26AWG, 300mm

Plunger Mass 5 grammes
 Total Mass 26 grammes

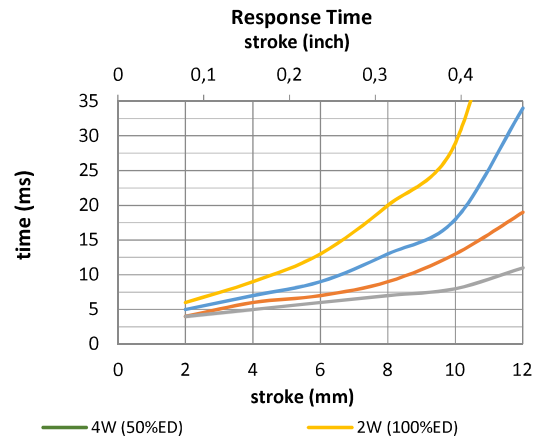
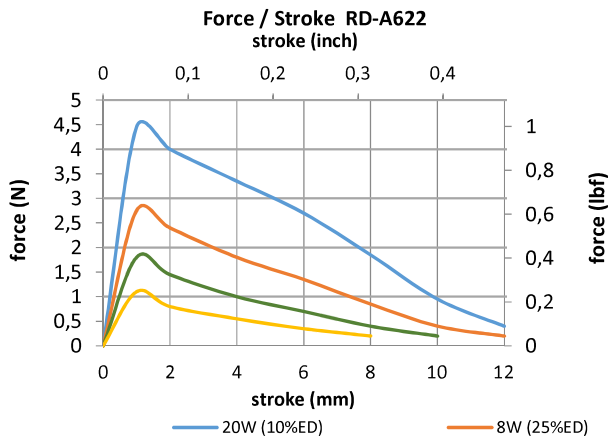
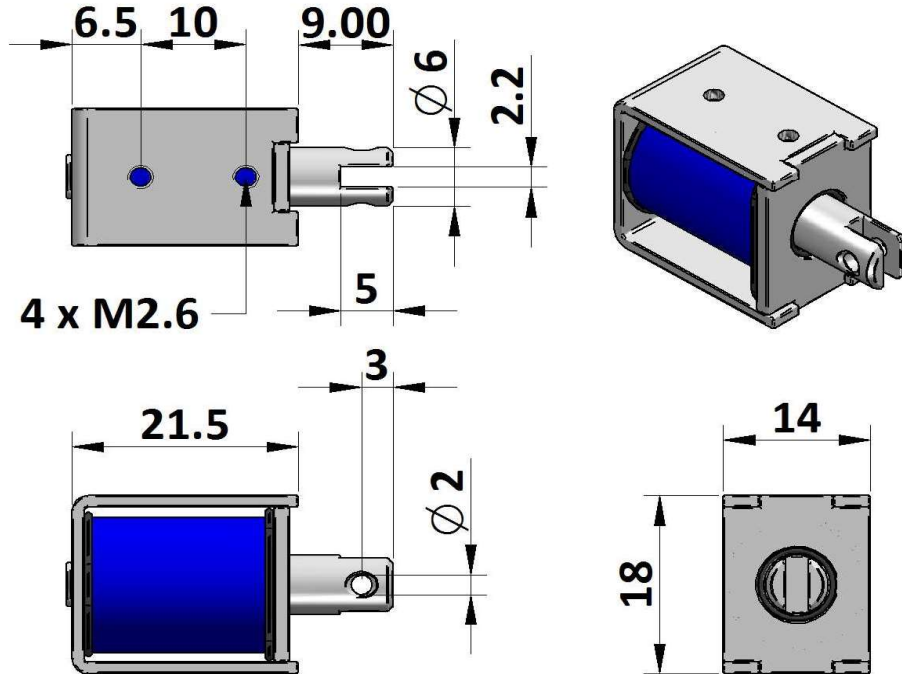

Data at 20°C, device performance measured without heat sink

duty cycle = $\frac{\text{"on" time}}{\text{"on" time} + \text{"off" time}} \times 100\%$		100% cont.	50% or less	25% or less	10% or less	
Max. "on" time in seconds		∞	168	59	16	
watts at 20°C		2,0	4,0	8,0	20,0	
ampere-turns at 20°						
AWG no.	resistance	number of turns	volts DC			
	$\Omega \pm 10\%$ (at 20°C)					
RD-A622-6v	18		6,0	8,5	12,0	19,0
RD-A622-12v	72		12,0	17,0	24,0	38,0
RD-A622-24v	288		24,0	34,0	48,0	76,0

Insulation Resistance >100MΩ, 500VDC Megger

Dielectric Strength 500VAC, 50/60Hz, 1 minute

Class A (105°C) insulation class

Geeplus reserves the right to change specifications without notice

www.geeplus.com