



General Specifications

Insulation Class	Class A (105°C)
Insulation Resistance >50MΩ, 500V DC	
Dielectric Strength 500V AC, 50/60 Hz, 1 minute	

Mass
EM0080
0.01kg
AP82
0.00kg

Part Number	Coil Resistance	Voltage	Included Options
EM0080-12	15 Ω	12 V	
EM0080-24	60 Ω	24 V	
EME0080-12	15 Ω	12 V	Ejector Pin
EME0080-24	60 Ω	24 V	Ejector Pin

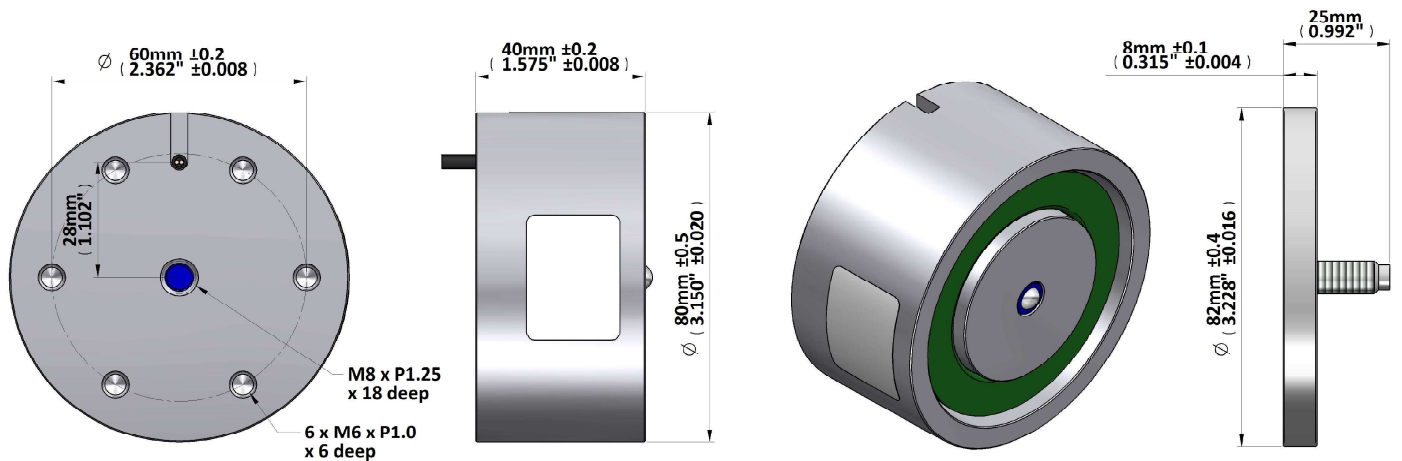

Holding Force Data

Separation (Airgap)	0.00 mm	0.00 mm	0.00 mm	0.00 mm	0.01 mm	0.01 mm
9.5W (100% ED)	2400	2130	1640	1300	325	230
4.8W (200% ED)	2140	1780	1430	1000	240	108
2.4W (400% ED)	2000	1400	1030	550	85	29

Holding force measured at 20°C to steel plate 8mm thick with surface Ra <1μm
 100% ED Power rating results in coil temperature rise of 65°C max with good heatsinking
 Force exerted by ejector pin in fully compressed condition 13N