



GEEPLUS

T1L-1253-xxV

$$\text{Duty Cycle} = \frac{\text{"on" time}}{\text{"on" time} + \text{"off" time}} \times 100\% \quad 50\% \text{ ED}$$

Coil Data

Maximum "on" time in seconds	20
Watts at 20°C	10
Ampere-Turns at 20°C	840

P/N

P/N	Resistance ±10% @ 20°C	Coil Turns	Volts DC	Release Current
T1L-1253-6v	3.6 Ω	515	6	1670 mA
T1L-1253-12v	14.4 Ω	1020	12	830 mA
T1L-1253-24v	57.6 Ω	2050	24	420 mA

General Parameters

Life Expectancy (Cycles)	200 000
Mass	211 grammes
Plunger Mass	42.91 grammes
Leadwires 250mm (10")min, UL1007, AWG24	
Isolation Class	A (105°C)
Dielectric Strength 1000V AC, 50/60Hz, 1min	
Insulation Res >100MΩ, 500V DC Megger	

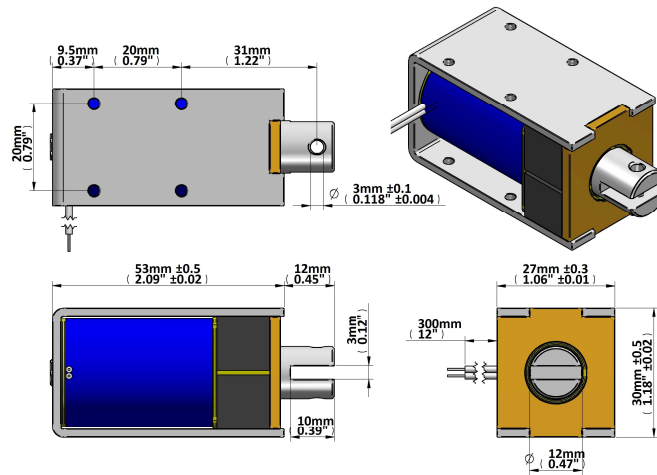

Force (N) vs Displacement (mm) & Release Characteristic

