



GEEPLUS

SH1LC-0524-xx

Duty Cycle = $\frac{\text{"on" time}}{\text{"on" time} + \text{"off" time}} \times 100\%$ 25% ED

Coil Data

Maximum "on" time in seconds	5
Watts at 20°C	8,4
Ampere-Turns at 20°C	452

P/N	Resistance ±10% @ 20°C	Coil Turns	Volts DC	Release Current
SH1LC-0524-06	4.3 Ω	340	6	360 mA
SH1LC-0524-12	17.1 Ω	630	12	200 mA
SH1LC-0524-24	68.6 Ω	1260	24	100 mA

General Parameters

Life Expectancy (Cycles)	200 000
Mass	14 grammes
Plunger Mass	3.14 grammes
Leadwires 250mm (10")min, UL1007, AWG28	
Isolation Class	A (105°C)
Dielectric Strength 1000V AC, 50/60Hz, 1min	
Insulation Res >100MΩ, 500V DC Megger	

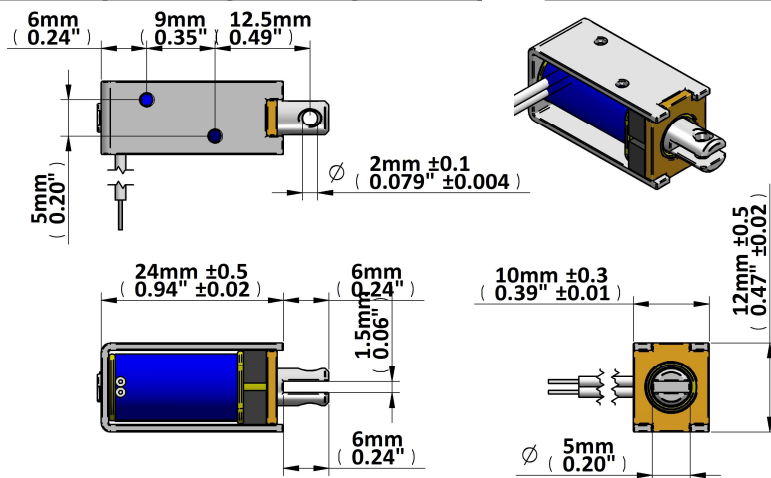

Force (N) vs Displacement (mm) & Release Characteristic

